

VT140WDESMD

Waveguide Electromechanical Switch

Features:

- Full Waveguide Band Coverage
- DPDT, Optional SPDT Configuration
- Equipped with Position Indicator

Applications:

- Transmit-Receive system
- Electronic Countermeasures System
- Commercial Ground Stations



Electrical Specifications

Parameter	Minimum	Typical	Maximum	Units
Frequency	11.9		18	GHz
VSWR			1.15	
Insertion Loss			0.15	dB
Isolation	70			dB
Switch Time			80	ms
Current			1	A
Voltage	22	24	32	V

Mechanical Specifications

Parameter	Specifications
Waveguide Type	WR62
Flange Type	UBR140
Material	Aluminum
Inside Finish	Natural conductive oxidation
Outside Finish	Black paint with control part
Weight	0.6 kg
Operating Temperature	-40°C~+70°C
Storage Temperature	-55°~ +85°C
Relative Humidity	80%
Switch Lifetime	100,000 times

VT140WDESMD

Waveguide Electromechanical Switch

Outline Drawings (Unless otherwise specified, all dimensions are in millimeters)

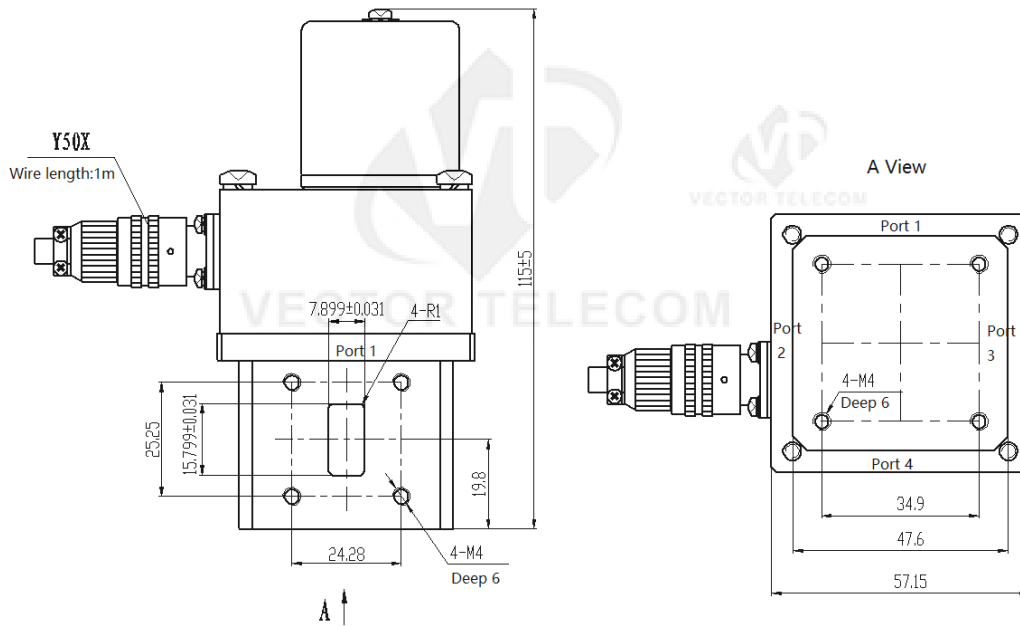

Wiring Definition

Pin Definition	Function	Note
1	VCC1(24V)	VCC1(POS1)
2	GND	
3	VCC2(24V)	VCC2(POS2)
4	J1	POS1: J1 and J2 conducting POS1: J1 and J2 conducting
5	J2	
6	J3	

VT140WDESMD

Waveguide Electromechanical Switch

Revision History

Date	Revision	Changes
09-Oct-2019	1	First release

Information furnished is believed to be accurate and reliable. However, Vector Telecom assumes no responsibility for the consequences of use of such information nor for any infringement of patents or other rights of third parties which may result from its use. No license is granted by implication or otherwise under any patent or patent rights of Vector Telecom. Specifications mentioned in this publication are subject to change without notice. This publication supersedes and replaces all information previously supplied. Vector Telecom products are not authorized for use as critical components in life support devices or systems without express written approval of Vector Telecom.

The Vector Telecom logo is a registered trademark of Vector Telecom Pty Ltd.

© 2021 Vector Telecom Pty Ltd - All rights reserved

Email: sales@vectortele.com

www.vectortele.com